

AMERICAN RANGE

QUALITY PROFESSIONAL COOKING EQUIPMENT

48" AMERICANA Gas RANGES

CUISINE SEALED TOWER BURNERS



RANGE TOP FEATURES

- Sealed tower burners deliver exceptional performance at every setting and are removable to provide easy cleanup.
- Three sizes of burners to serve your everyday needs:
25,000 BTU (lg), **18,000 BTU (med)**, **13,000 BTU (sm)**
- Variable flame settings for all Cuisine sealed burners.
- Automatic, electronic re-ignition.
- Continuous cast iron grates allow for easy transfer of pots and pans across the entire cooking surface.
- Sealed single piece porcelainized cook top can hold more than a gallon of spills.
- Dual action valves provide easy, safe operation.
- **Stainless steel Island Back trim included and installed.**



OVEN FEATURES

30" Convection Oven (4.6 CU.FT.)

Oven Bake Burner 30,000 BTU

Broil Burner 15,000 BTU

Convection fan

Modes: Bake, Convection Bake, Broil

18" Bake Oven (2.6 CU.FT.)

Oven Bake Burner 18,500 BTU

Modes: Bake

- Red indicator lights.
- Functions: Baking, Convection Baking, Broiling.
- Convection system creates uniform air flow.
- Two chrome plated, heavy-duty racks with four positions on heavy gauge chrome side supports.
- Ceramic infrared broiler provides rapid searing at 1,800°F (983°C).



Model # ARR-648GD
Shown with optional leg caps.



ARR-848

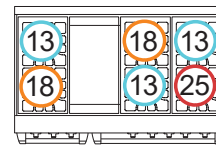

ARR-648GD

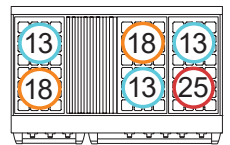

ARR-648GR

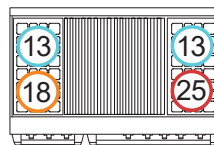

ARR-4482GR

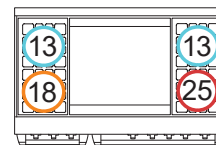

ARR-4482GD

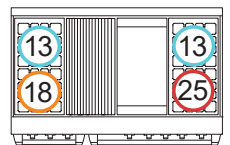

ARR-448GDGR

BURNER CONFIGURATIONS

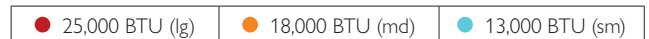

CONVECTION OVEN TECHNOLOGY



Balanced heat distribution is essential when baking, roasting, and dehydrating food. The American Range convection oven technology features a convection motor and louvered side panels to enhance uniform heat distribution throughout the large oven cavity. The strategic placement of the convection fan ensures

consistent heat distribution.

CONVECTION OVENS ARE GREEN TECHNOLOGY

The highly efficient design of the Convection Oven uses less gas versus a standard oven.

CUSTOMIZE YOUR RANGE

Pick any RAL color to match the color that best suits your lifestyle.



See ralcolorchart.com for color options for the front panel and toe kick. Knobs cannot be customized.



www.AmericanRangeHome.com



48" AMERICANA GAS RANGES

CUISINE SEALED TOWER BURNERS

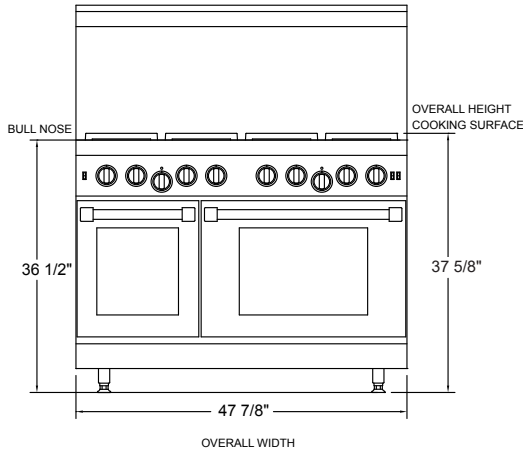

FRONT VIEW

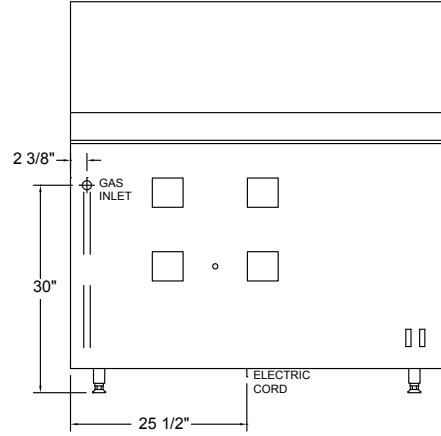

REAR VIEW

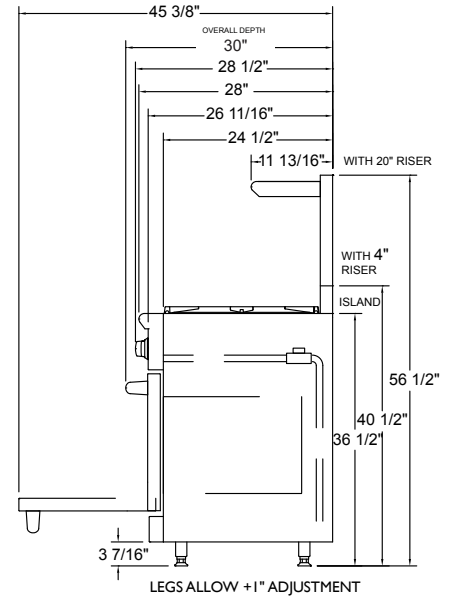

SIDE VIEW

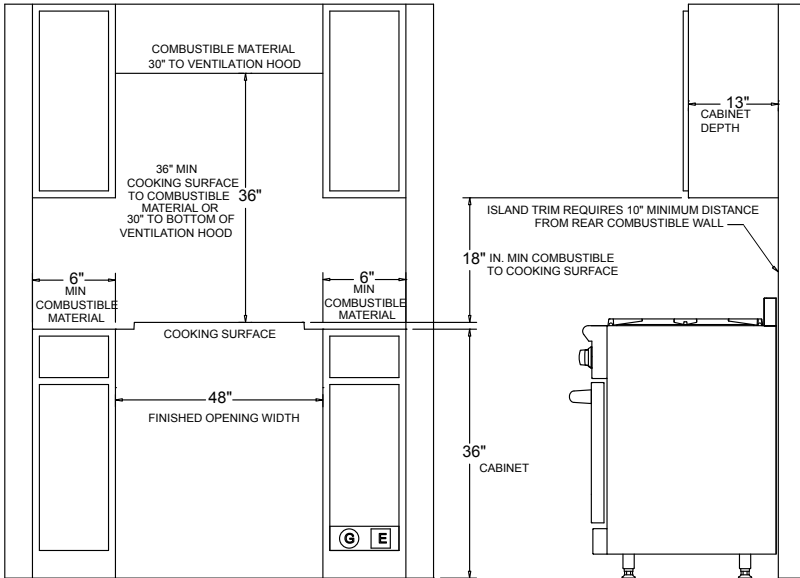

MUST SHIP FROM FACTORY WITH PROPER GAS TYPE
 N= Natural Gas L= LP Gas. Must provide N or L after model number for type of gas needed. (Example: ARR636-L) Must specify elevation if over 2000 ft. when ordering.

***ELECTRICAL REQUIREMENTS**

A grounded three prong plug with proper polarity must be used.

A manual gas shut-off valve must be installed external to the appliance, in a location accessible from the front, for the purpose of shutting off the gas supply. This is a vented appliance. To be used in conjunction with a suitable vent hood only.

**The American Range Company continually improves its products and reserves the right to change materials, specifications and dimensions without notice. This unit is manufactured for residential use only.

RECOMMENDED LOCATION OF GAS AND ELECTRICAL SUPPLY

ISLAND OR PENINSULA INSTALLATIONS 10" MINIMUM CLEARANCE FROM BACK OF RANGE TO COMBUSTIBLE SURFACE

ISLAND TRIM 0 IN. CLEARANCE TO NON COMBUSTIBLE SURFACE

NO SIDE WALL ABOVE COOKING SURFACE

TECHNICAL SPECIFICATIONS

Overall Oven Capacity	18" Bake Oven 2.5 CU. FT. and 30" Convection 4.6 CU. FT.	Infrared Broiler	15,000 BTU 30" Oven
Oven Cavity Dimensions	14" W x 20 1/2" D x 15" H (18" Oven) (356 x 521 x 381) 26" W x 20 1/2" D x 15" H (30" Oven) (660 x 521 x 381)	Oven Bake Burner	18,500 BTU 18" Oven 30,000 BTU 30" Oven
Surface Burner Rating	25,000 BTU (lg) – 18,000 BTU (md) – 13,000 BTU (sm)	Grill Burner Rating	15,000 BTU for every 11" section
Gas Supply	7" W.C. Natural, 11" W.C. Propane	Griddle Burner Rating	20,000 BTU for every 11" section
		Electrical Supply	120 VAC 15 amp 60 Hz Single Phase

Model Number	Description	Overall Dimensions	Total Gas Connection Rating	Shipping Weight	Crated Dimension
ARR-848	8 burners	47 7/8" W x 30" D x 37 5/8" H (1216 x 762 x 956)	194,500 BTU (57 kW)	660 Lbs (300 kg)	49" W x 31" D x 45 1/2" H (1245 x 788 x 1156)
ARR-648GD	6 burners and griddle	47 7/8" W x 30" D x 37 5/8" H (1216 x 762 x 956)	183,500 BTU (54 kW)	660 Lbs (300 kg)	49" W x 31" D x 45 1/2" H (1245 x 788 x 1156)
ARR-648GR	6 burners and grill	47 7/8" W x 30" D x 37 5/8" H (1216 x 762 x 956)	178,500 BTU (53 kW)	660 Lbs (300 kg)	49" W x 31" D x 45 1/2" H (1245 x 788 x 1156)
ARR-4482GD	4 burners and 2 griddles	47 7/8" W x 30" D x 37 5/8" H (1216 x 762 x 956)	172,500 BTU (51 kW)	660 Lbs (300 kg)	49" W x 31" D x 45 1/2" H (1245 x 788 x 1156)
ARR-4482GR	4 burners and 2 grills	47 7/8" W x 30" D x 37 5/8" H (1216 x 762 x 956)	162,500 BTU (48 kW)	660 Lbs (300 kg)	49" W x 31" D x 45 1/2" H (1245 x 788 x 1156)
ARR-448GDGR	4 burners 1 griddle 1 grill	47 7/8" W x 30" D x 37 5/8" H (1216 x 762 x 956)	167,500 BTU (38 kW)	660 Lbs (300 kg)	49" W x 31" D x 45 1/2" H (1245 x 788 x 1156)

ACCESSORIES

OPTIONS (FACTORY INSTALLED)

1" Island Back (standard)	ARR-48SIB	12" Griddle Cover	ARR-GDCOV12-S	Wok Adapter	ARR-WOK	11" Chrome Flat Griddle Plate	MC11-FS
1" Island Back (welded)	ARR-48IB	12" Grill Cover	ARR-GRCOV12	Extra Oven Rack – 18" Oven	R31035	11" Chrome Grooved Griddle Plate	MC11-GG
4" Stub Back	ARR-484SB	12" Griddle Plate	ARR-PGP12	Extra Oven Rack – 30" Oven	R31037	22" Chrome Flat Finish Griddle Plate	MC22FS
20" High Back w/ Shelf	ARR-4821HBS	24" Griddle Plate	ARR-PGP24	Easy Glide Rack 18"	R31032	22" Cr L. Matte & R. Grooved GR Plate	MC22HG
S/S Leg Caps (3)	ARR-3LC	24" Griddle Cover	ARR-GDCOV24-S	Easy Glide Rack 30"	R31033	22" Chrome Flat Finish Griddle Plate	MC22FS
12" Cutting Board	ARR-CUTB-12	24" Grill Cover	ARR-GRCOV24	Porcelainized Broiler Pan	R31005	22" Griddle Plate w/ Flavor Separator	MC22-SP

NMFCODE: 25970-2 Class: 85
 © Copyright 2022 American Range
 All Rights Reserved
 R70444 RevB 08312022



QUALITY PROFESSIONAL COOKING EQUIPMENT

4580 N Walnut Rd 13592 Desmond St
 N. Las Vegas, NV 89081 Pacoima, CA 91331
 (888) 753-9898
 www.AmericanRangehome.com